

# NPN SILICON TRANSISTOR

## POWER AMPLIFIER APPLICATIONS POWER SWITCHING APPLICATIONS

### FEATURES

- \* Low saturation voltage:  $V_{CE(SAT)} = 0.5V$  (Max.)
- \* High speed switching time:  $T_{STG} = 1.0\mu s$  (Typ.)

**MARKING : 2655**

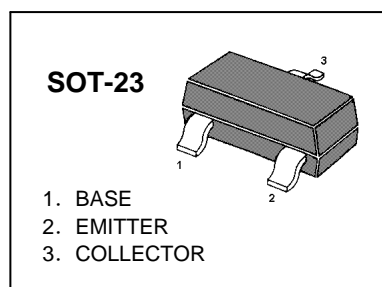

### ABSOLUTE MAXIMUM RATINGS ( $T_A = 25^\circ C$ , unless otherwise specified )

PARAMETER	SYMBOL	RATING	UNIT
Collector-Base Voltage	$V_{CBO}$	50	V
Collector-Emitter Voltage	$V_{CEO}$	50	V
Emitter-Base Voltage	$V_{EBO}$	5	V
Collector Current	$I_C$	2	A
Collector Current (Pulse) (Note 1)	$I_{CP}$	3	A
Base Current	$I_B$	0.5	A
Collector Power Dissipation	SOT-23	350	mW
	TO-92	900	
Junction Temperature	$T_J$	150	$^\circ C$
Storage Temperature	$T_{STG}$	-55 ~ +150	$^\circ C$

Note: 1.  $P_W \leq 16ms$ , Duty Cycle  $\leq 50\%$ .

- Absolute maximum ratings are those values beyond which the device could be permanently damaged. Absolute maximum ratings are stress ratings only and functional device operation is not implied.

### ELECTRICAL CHARACTERISTICS ( $T_A = 25^\circ C$ , unless otherwise specified)

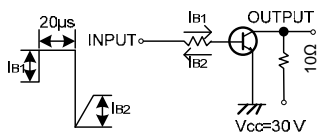
PARAMETER	SYMBOL	TEST CONDITIONS	MIN	TYP	MAX	UNIT
Collector Emitter Breakdown Voltage	$BV_{CEO}$	$I_C = 10mA, I_B = 0$	50			V
Collector Cut-off Current	$I_{CBO}$	$V_{CB} = 50V, I_E = 0$			1.0	$\mu A$
Emitter Cut-off Current	$I_{EBO}$	$V_{EB} = 5V, I_C = 0$			1.0	$\mu A$
DC Current Gain	$h_{FE(1)}$	$V_{CE} = 2V, I_C = 0.5A$	70		240	
	$h_{FE(2)}$	$V_{CE} = 2V, I_C = 1.5A$	40			
Collector-Emitter Saturation Voltage	$V_{CE(SAT)}$	$I_C = 1A, I_B = 0.05A$			0.5	V
Base- Emitter Saturation Voltage	$V_{BE(SAT)}$	$I_C = 1A, I_B = 0.05A$			1.2	V
Transition Frequency	$f_T$	$V_{CE} = 2V, I_C = 0.5A$		100		MHz
Collector Output Capacitance	$C_{OB}$	$V_{CB} = 10V, I_E = 0, f = 1MHz$		30		pF
Switching Time(Turn-on Time)	$t_{ON}$	 <p><math>I_{B1} = -I_{B2} = 0.05A</math> DUTY CYCLE <math>\leq 1\%</math></p>		0.1		$\mu s$

### CLASSIFICATION OF $h_{FE(1)}$

RANK	O	Y
RANGE	70-140	120-240

■ TYPICAL CHARACTERISTICS

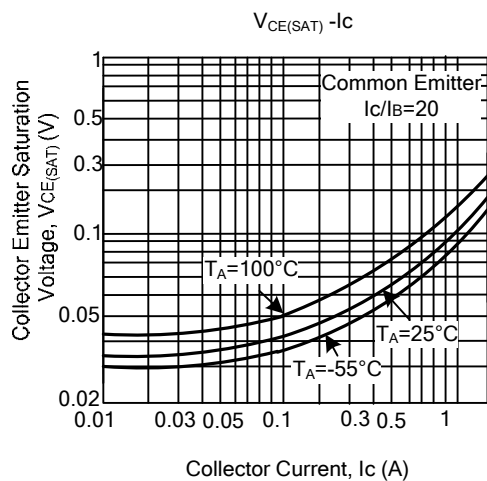
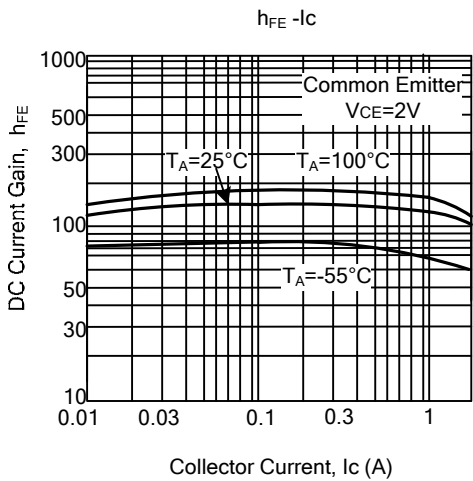
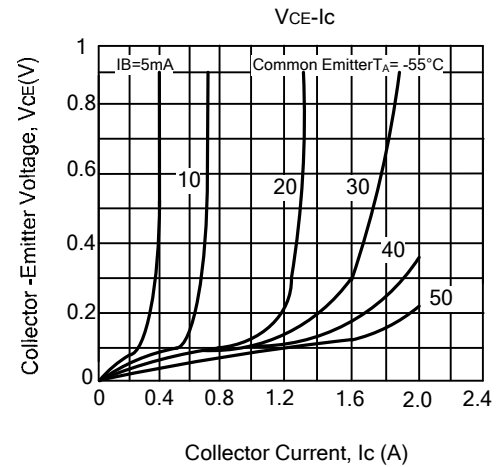
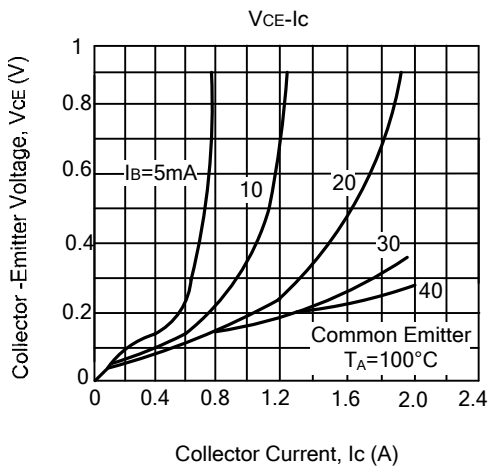
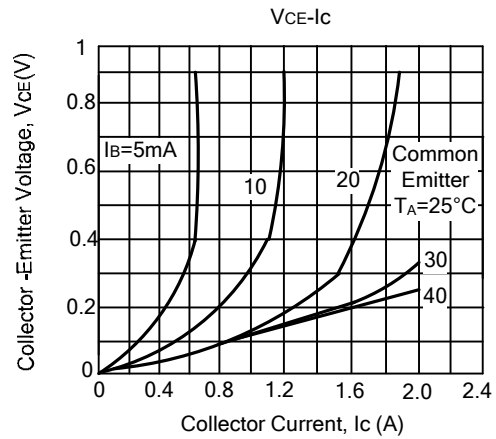
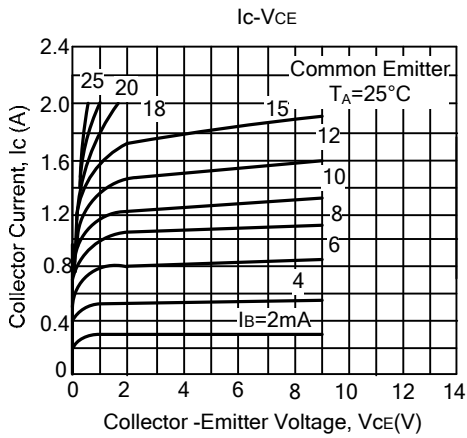

■ TYPICAL CHARACTERISTICS(Cont.)

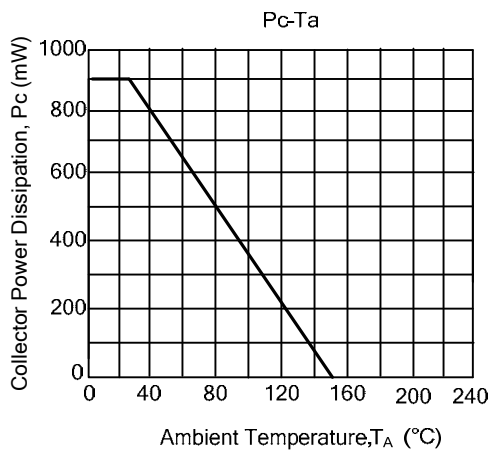
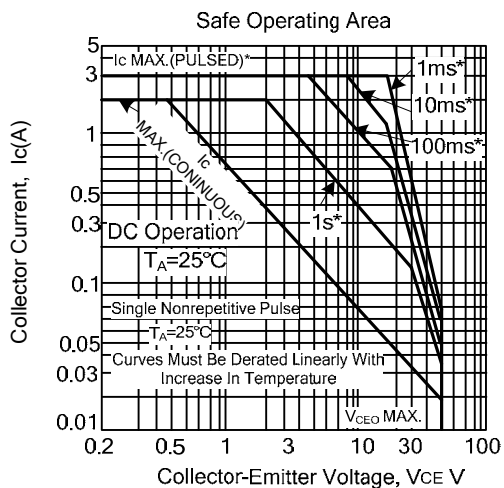
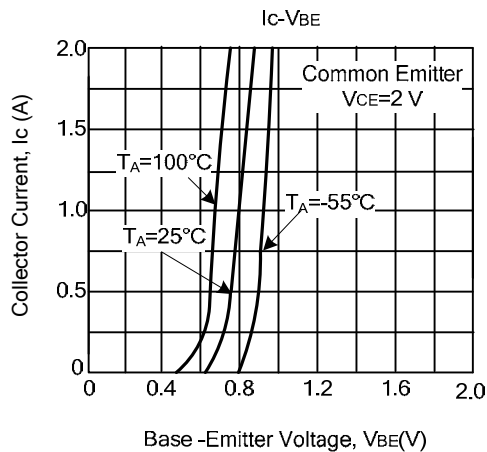
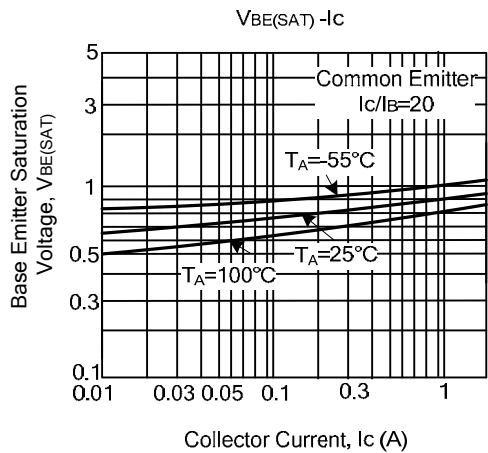

**PACKAGE OUTLINE**

Plastic surface mounted package; 3 leads

SOT-23

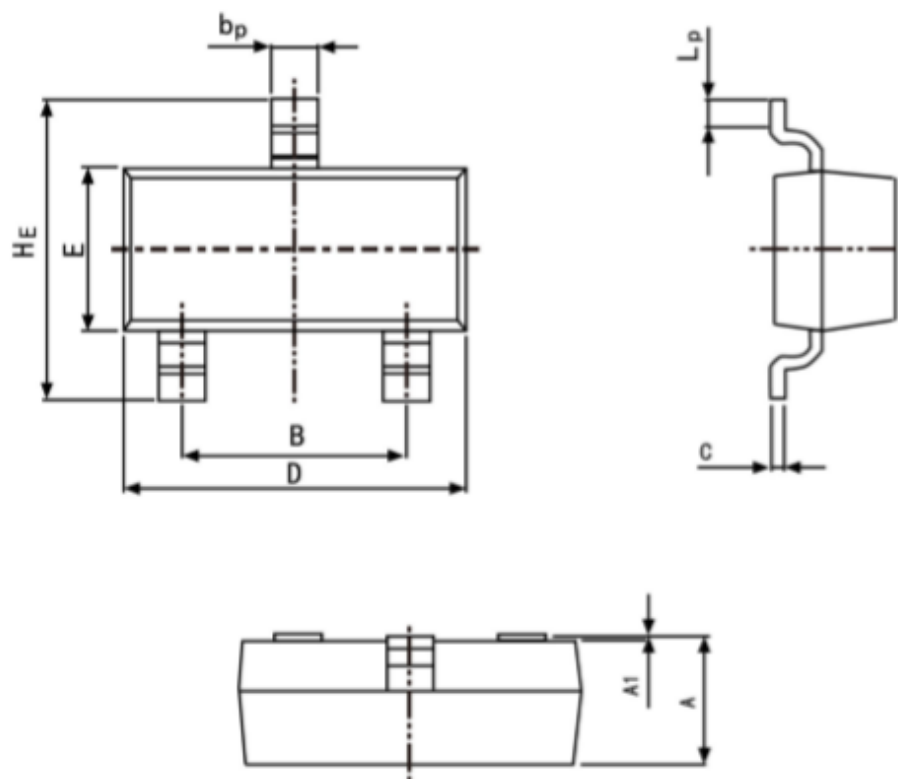

Symbol	Dimension in Millimeters	
	Min	Max
A	0.95	1.40
B	1.78	2.04
bp	0.35	0.50
C	0.08	0.19
D	2.70	3.10
E	1.20	1.65
HE	2.20	3.00
A1	0.100	0.013
Lp	0.20	0.50